

ZenPoint DigitalCenter 5

MusicCenter **ZenPoint**

Albums **Jukebox** 13-24 of 52 albums

Classix Nouveaux Living in Oblivion: The 80'...	Craig David The Story Goes	Def Leppard Rock Of Ages: The Definit...	Electric Light Orche... Xanadu	Eurythmics Eurythmics Greatest Hits	Frank Sinatra My Way - The Best of Fran...
Giant Last Of The Runaways	Grease Grease	Greatest hits britne... Greatest hits britney spears	High School Musical 2 High School Musical 2	James Blunt Back To Bedlam	Kelly Clarkson Breakaway

A B **C** D E F G H I J K L M N O P Q R S T U V W X Y Z ~

Grease Frankie Valli 01:01	ABBA GOLD Dancing Queen Abba 02:27	Because of You Kelly Clarkson 06:19	Goodbye My Lover James Blunt 09:58	Beat It Michael Jackson 14:16
---	---	--	---	--

Albums **Artists** **Songs** **Genres** **Years** **Search** **Playlist** **Back** **Pause** **Next** **Volume** **Home**

Table of Contents

Administration	5
General	5
Volume on start up.....	5
Language.....	5
Options	6
Party mode security	7
Image quality	7
Screensaver	8
Attractive Mode	8
External programs	9
Program details	9
Skins	10
Effects	11
Plugins.....	12
Plugin details.....	12
Monitors	14
Update	14
Facebook.....	15
Allow ZenPoint to upload your amazing moments using the DigitalCenter	15
KaraokeCenter	16
Karaoke directories	16
MovieCenter.....	17
Movie directories.....	17
File types.....	17
Use Imdb.....	17
Enhanced Video Renderer.....	17
External players.....	17
MusicCenter	19
Music directories	19
Options	19
Artist ignore list	21
Playlists.....	22

Playlist details	22
Statistics	24
Themes	25
Themes	25
Theme Details	25
PhotoCenter	26
Photo directories	26
Camera settings	26
Slideshow settings	27
Slideshow speed	27
RadioCenter	28
Radio information	28
VideoCenter	29
Video directories	29
WeatherCenter	29
DigitalCenter	31
Settings	32
Skins	32
Themes	32
Effects	32
Playlist	32
Languages	32
Reset music	33
Administration	33
Party mode	33
Rip CD	33
Remote Control	33
MusicCenter	34
Albums	35
Navigation	35
Grouping	35
Artists	36
Navigation	36

Songs	37
Navigation	37
Sorting	37
Genres	38
Navigation	38
Years	38
Navigation	38
Search	39
Search type	39
Navigation	39
Playlist	40
Navigation	40
Song select / Album select	41
Navigation	41
Sorting	41
Show as albums.....	41
MovieCenter	42
Add a description to your movie.....	43
KaraokeCenter	44
RadioCenter.....	45
PhotoCenter	46
Share with facebook.....	46
WeatherCenter.....	46
Trial version / Limited edition.....	47
Limitations.....	47
Purchase	47
Setting up a coin acceptor	48
Your comments.....	50
FAQ.....	50
1. How do I add music to the MusicCenter?	50
2. How do I change the title or album name of my music?.....	50
3. How do I add descriptions to my photos?	50
4. How can I streamline the volume of all my music?	51

5. What is Party Mode?.....	51
6. How to make a jukebox with ZenPoint MusicCenter?	52
7. How to create a playlist?	52
8. How do I add pictures and titles to my movies?.....	53
9. The MusicCenter plays the song but where is the sound?	53
10. The MovieCenter doesn't play any movies.....	53
11. How to minimize the DigitalCenter?	53
12. How to sort albums by artist?.....	53
13. How to sort albums songs by tracks?	53
14. How to create my own skin?	54
15. How to remove the ZenPoint logo?.....	54
16. How can I jump to the album of a search result	54
Releases	55
Release 5.0.....	55
Release 4.5.....	55
Release 4.4.....	55
Release 4.3.....	55
Release 4.2.....	56
Release 4.1.....	56
Release 4.0.....	56
Release 3.9.....	56
Release 3.8.....	57
Release 3.7.....	57
Release 3.6.....	58
Release 3.5.....	58
Release 3.4.....	58

Administration

Inside the administration you can setup your entire DigitalCenter.

You are able to select between many different languages, skins, effects and manage all of your plugins. It is also possible to add your own favourite applications to the DigitalCenter.



General

Volume on start up

Choose the default volume level of your DigitalCenter.

Language

Choose your preferred language. If your language isn't in the list, you have the ability to create your own language. Look at the directory "[Installed folder]\Languages". If you decide to change or create your own language, please let us know, and we will add it to our next release.

Options

Customize all the DigitalCenter features.

Touchscreen (hide mouse)

If you have a touch screen select this to hide the mouse and disable mouse over on buttons.

Stretch display

If you are running the DigitalCenter on a widescreen you have the possibility to stretch the application display.

Start in party mode (password protected)

When you are in party mode you have to use a password to go in and out of the various plugins. The concept behind the party mode is that you can ensure that your playlists will not be changed by anyone beside yourself, and that your guests do not have permission to more than you have allowed them. The rules for party mode will be set up on the various playlists. No changes made in party mode will be saved, unless you are logged in with the "admin password".

In addition, it is also possible to give one of your guests extra power through a "party password". No matter what this user makes of changes, nothing will be saved, and is only used as long as the DigitalCenter is running. This is useful if you want another person to control the music at your party, without making chaos in your system. If you're running a rental company, you can give the renter this password and the person has full control at his party, and you still know your playlists and default settings are intact when you get your DigitalCenter back.

As a party user you have the ability to manage playlists, audio level, skins, language and effects or change the party password.

If you're not in party mode or logged in as the administrator, every change you make will be saved and remembered.

Close DigitalCenter on ESC

Close the DigitalCenter on ESC.

Show administration in setup

Show the administration program from the setup when you are not in party mode. When you are in party mode and logged in as the administrator, the administration will always be visible.

Play intro music on start

Play the ZenPoint intro music when you start the DigitalCenter. This music can be replaced with another mp3 file, just replace the file "`\\digitalcenter\\music\\ZenPointIntro01.mp3`" with your own music file.

Hide 'party mode' from setup

Hide party mode button from the setup.

Use hotkey (ctrl+a) for administration

Open "DigitalCenter Administration" when you press CTRL + A.

Show 'exit' in start menu

Show exit button inside the home screen of the DigitalCenter.

Enable statistics

Turn on and off the statistics.

Show splash screen

Show the splash screen on start up.

Show copyright

Show copyright line.

Stop playing when playlist is empty

Should the DigitalCenter stop playing when the playlist is empty?

Allow media keys in party mode

If you run the DigitalCenter together with a keyboard, you are able to use hotkeys in party mode. In party mode you can turn this feature off.

Disable system keys

Disable system keys like etc. Ctrl+Tab.

Party mode security

Party Password

Change party user password. (Default: 1234)

Admin Password

Change the admin user password. (Default: admin)

Image quality

Change the quality of the images in DigitalCenter. If you want a fast generation of the images when you are importing music, photos or movies and don't care about the quality, you can choose "Better performance". If you have a fast computer and don't care about the performance, then choose "Better quality".

Better performance

Generate the thumbnails fast but in low quality.

Better quality

Slow generation of images, but high quality.

Clear history

All the images generated by the DigitalCenter are cached for faster import on your second run. This button tell the system to clear all cached images, and next time you run the DigitalCenter everything is collected again from the beginning.

Screensaver

The screensaver is the sleeping mode when the DigitalCenter hasn't been touch for X minutes. If you are running dual monitors the screensaver will always run on your secondary monitor.

Use Screensaver

Do you want the DigitalCenter to use screen saver when the DigitalCenter hasn't been used for X minutes.

Start after

Start the screensaver after X minutes.

Attractive Mode

If you have turned on "Stop playing when playlist is empty" you are able to setup attractive mode. This mean that your DigitalCenter will play a song after X minutes to inspire your guests to get up and choose a new song.

Attractive mode

Turn this on if you want to use the attractive mode.

Play when silence for

Play attractive music after X minutes.

External programs

Inside the external programs you can customize the home screen and setup of the DigitalCenter. You can select the external programs you want to be able to start inside the DigitalCenter.

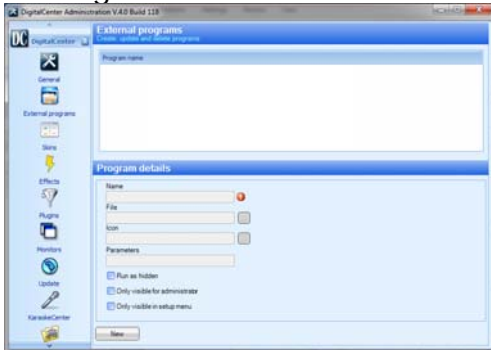

Program details

Name

The title you want to be used for your external program.

File

Browse for the exe file you.

Icon

Browse for an icon to use. If you want to use the shell icon of the file then leave this field empty.

Parameters

If your program requires any parameters, then use this field.

Run as hidden

Run the external program in the background when the DigitalCenter is running.

Only visible for administrator

In party mode you have to be logged in as an administrator to see this external program.

Only visible in setup menu

The program will only be showed inside the setup.

Skins

Choose the default skin for your DigitalCenter. You also have the opportunity to create your own skin for your DigitalCenter.

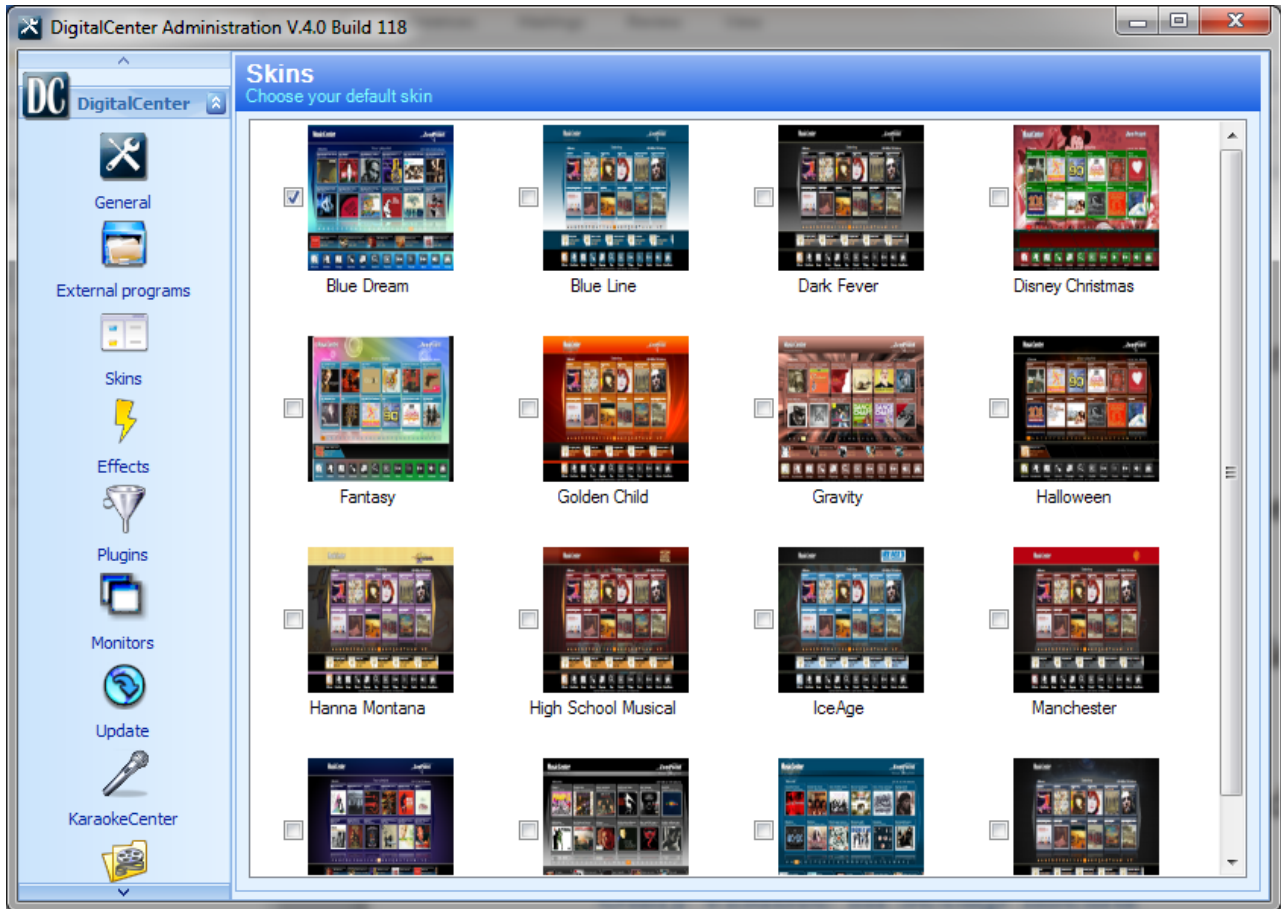

Effects

Choose the default effect for your DigitalCenter.

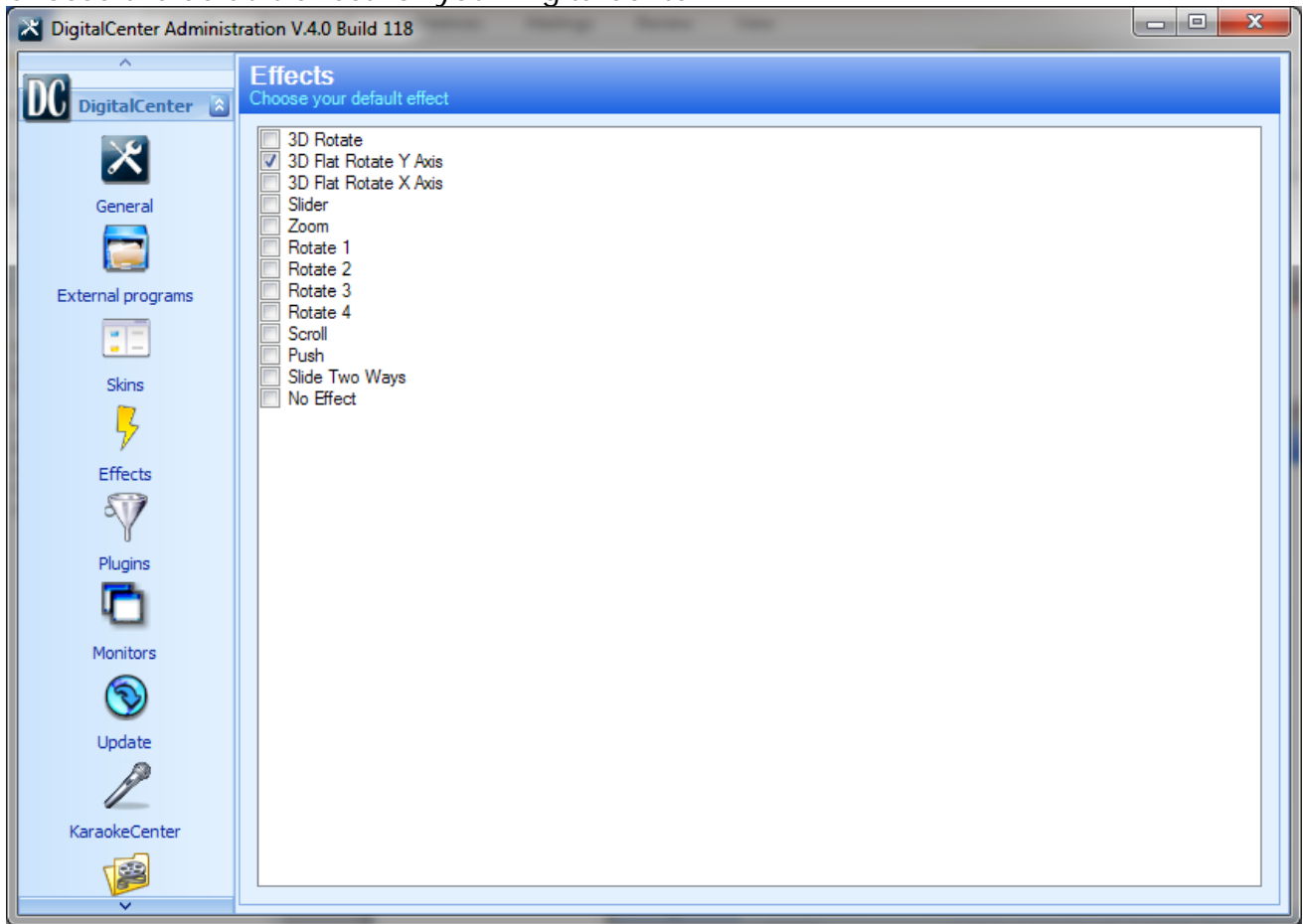

Plugins

Shows all the plugins you have installed in your DigitalCenter. You have opportunity to deselect the ones you don't want to use. If you only have one plugin selected, the DigitalCenter will automatically run this plugin on start up.

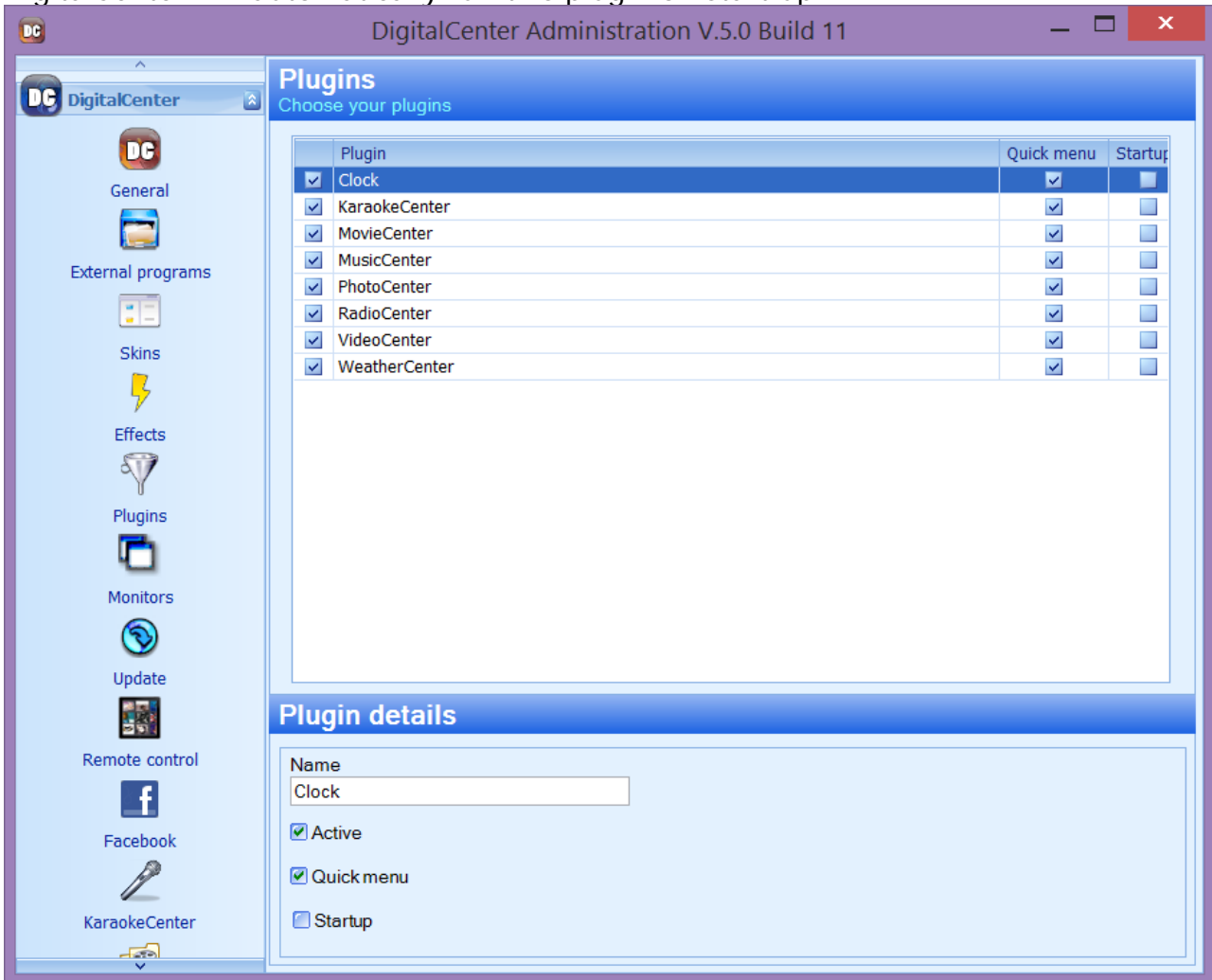

Plugin details

Name

Choose a name for the plugin

Active

Is the current plugin active.

Quick menu

Show current plugin in the quick menu when you are in party mode.



Start up

Choose the plugin to use when the DigitalCenter is started.

Monitors

If you are running dual monitors, you have the opportunity to use both the monitors in the DigitalCenter.

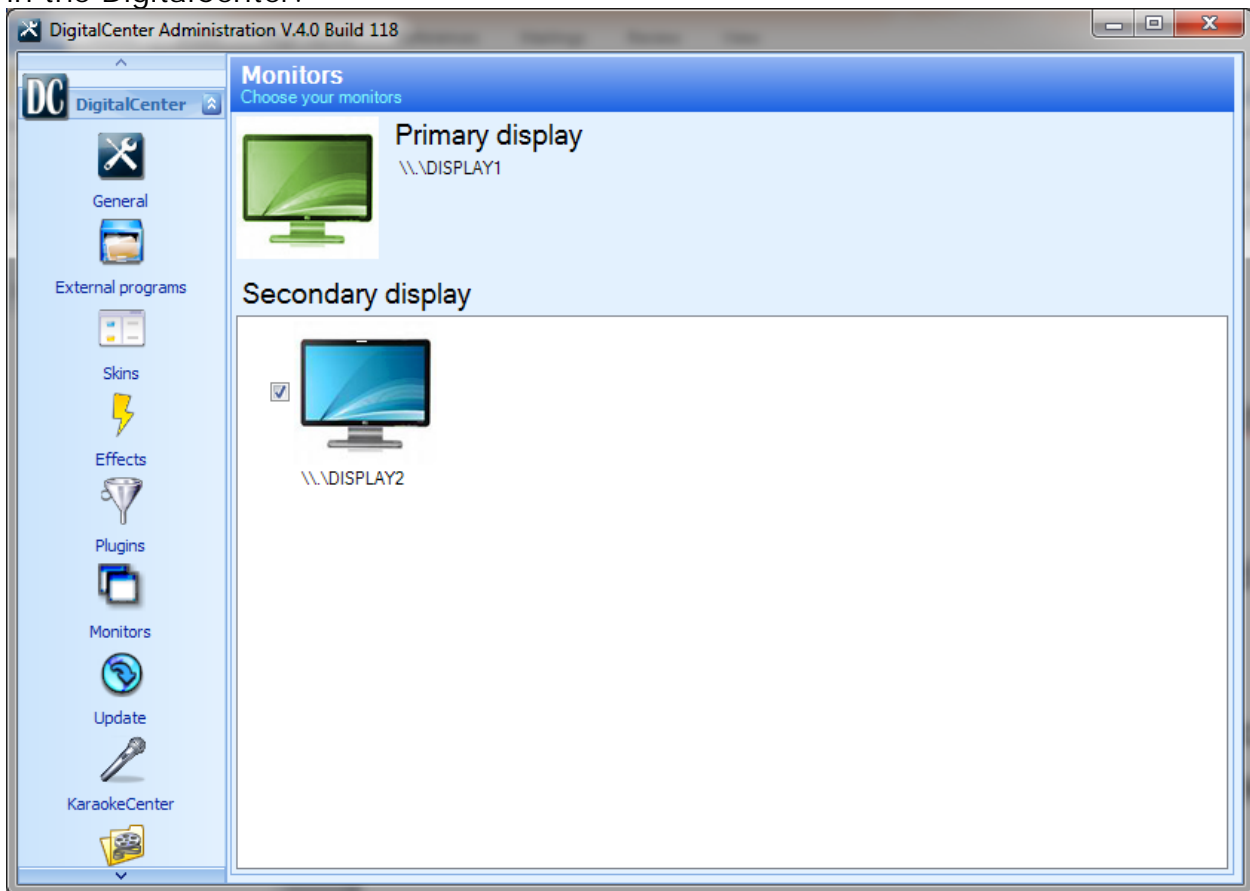

Update

Check for new updates for your DigitalCenter.

Facebook

It is possible allow the DigitalCenter to post photos to your wall directly from the DigitalCenter. This feature is nice when you are having a party and you have connected a camera you are able to take photos and send them directly to your profile.

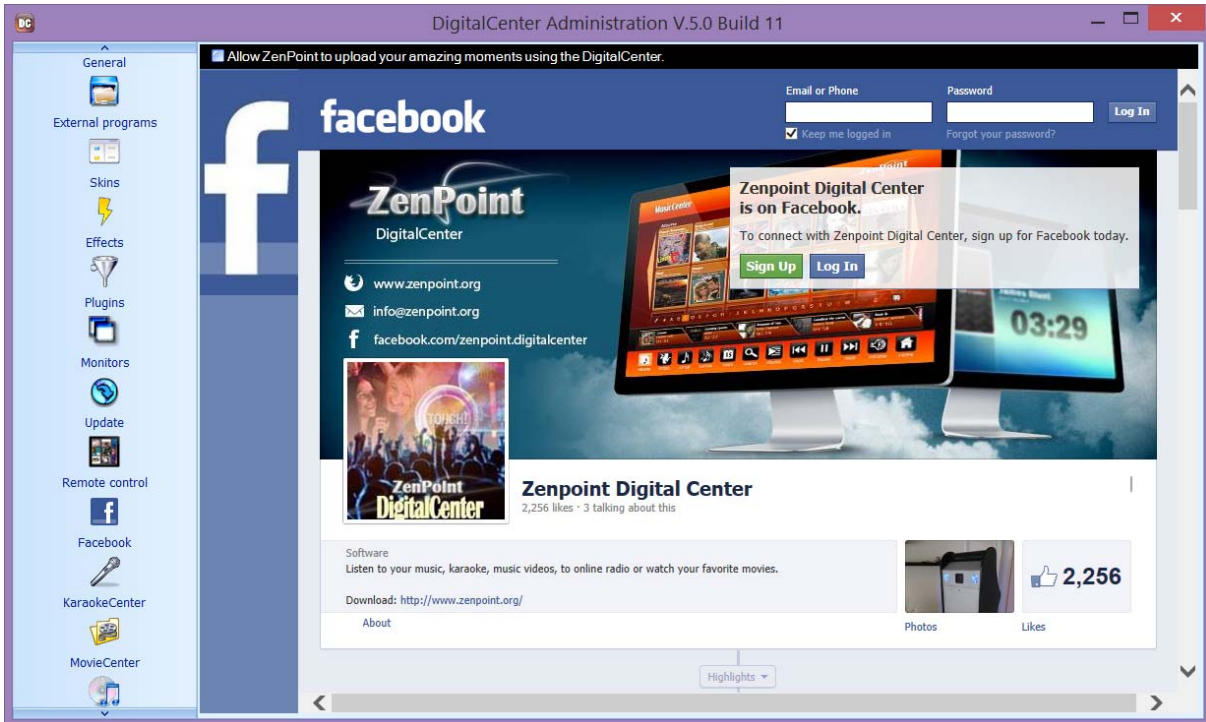

Allow ZenPoint to upload your amazing moments using the DigitalCenter

Turn this on to make it possible to upload photos from the PhotoCenter to your facebook wall.

KaraokeCenter

The KaraokeCenter supports CDG and MP3 files.

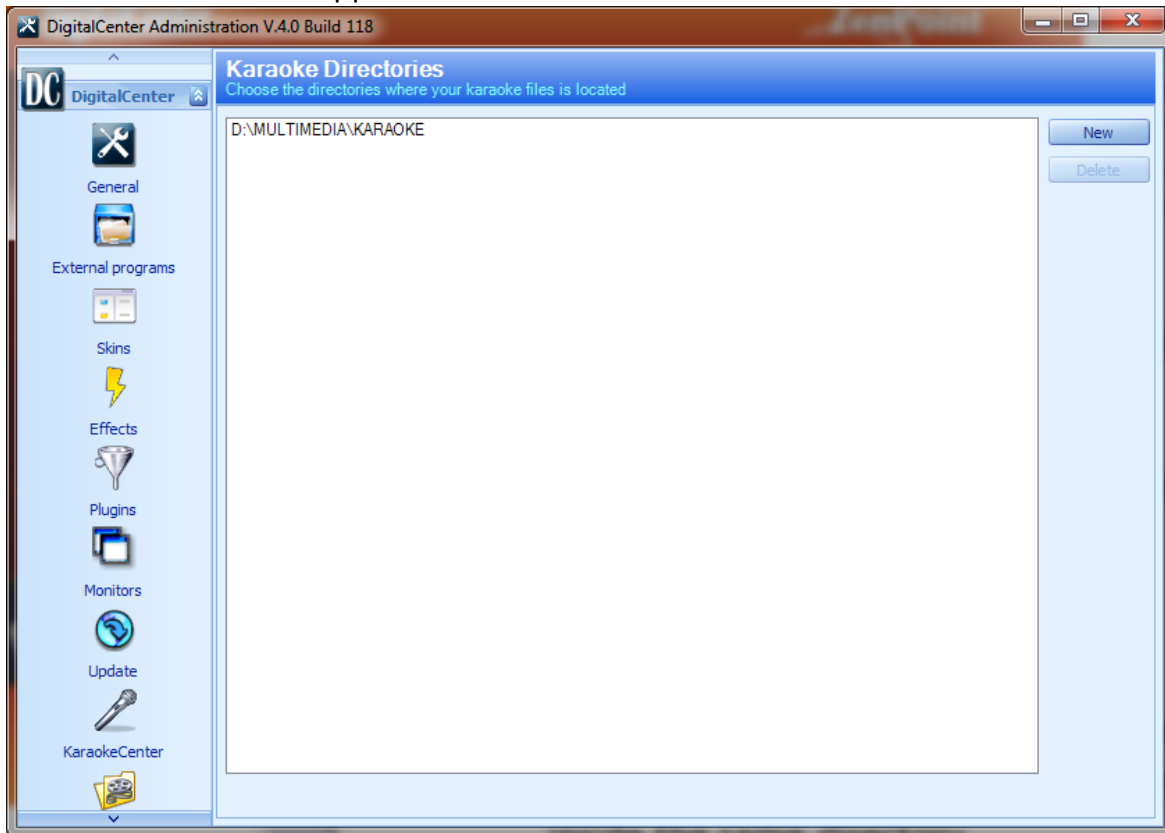

Karaoke directories

Choose the directories where your karaoke files are located.

To have your karaoke files collected, you have to have an MP3 file and a CDG file with the same name inside the same directory or packed inside a zip file.

For example:

C:\MyKaraoke
-Thriller.mp3
-Thriller.cdg

Or

C:\MyKaraoke
- Thriller.zip
-Thriller.mp3
-Thriller.cdg

MovieCenter

The MovieCenter supports AVI, MKV, DIVX and MPG files.

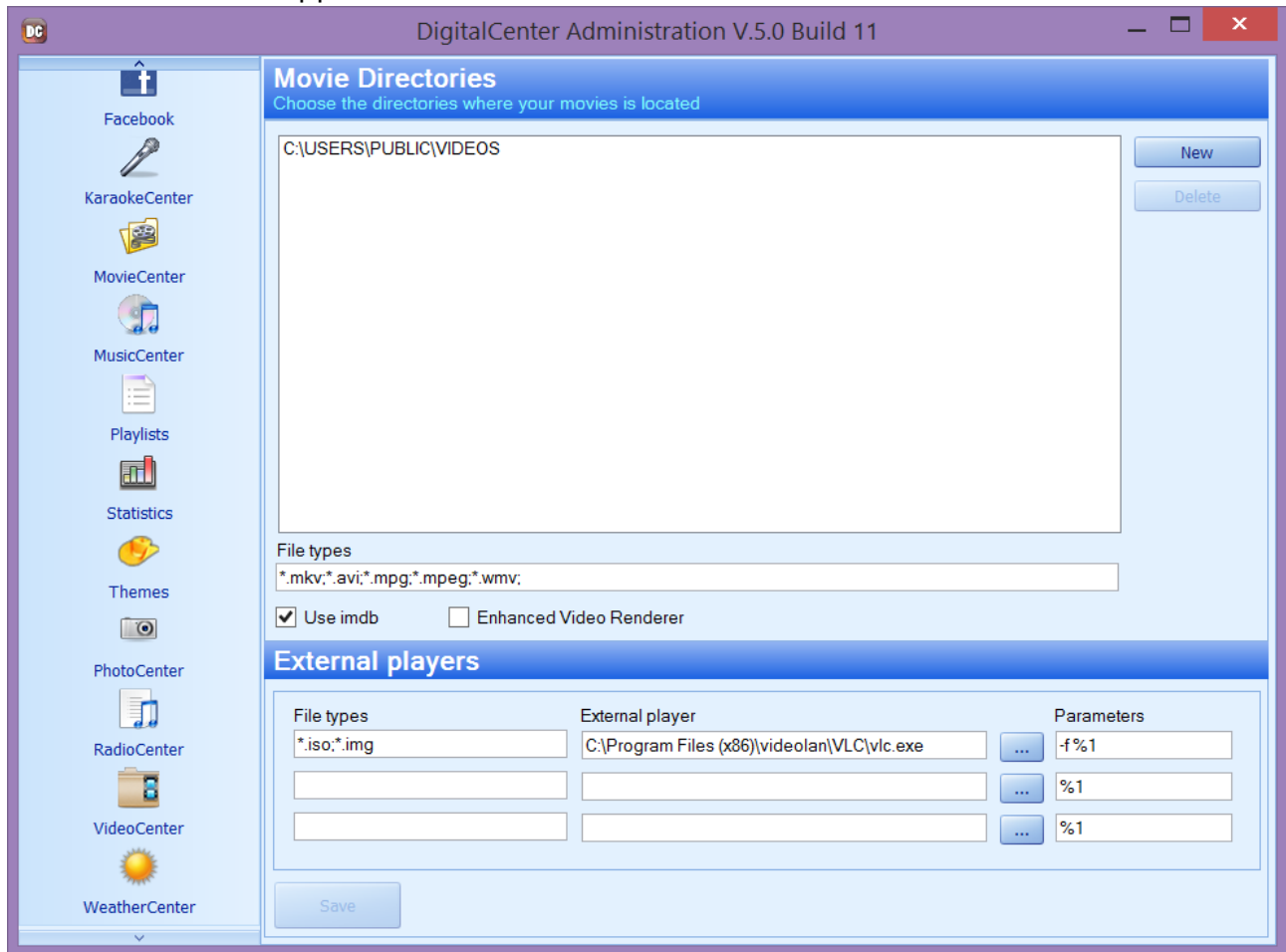

Movie directories

Choose the directories where your movies are located.

File types

Which file types to use by the internal player. Make sure you have the right codec's.

Use Imdb

If possible get the movie information from Imdb.

Enhanced Video Renderer

Use enhanced video render.

External players

If you have some movie files which not supported by the MovieCenter, you are able to connect your MovieCenter with external movie players, for example connect *.iso files with VLC player. Then all your .iso files are collected and showed inside the MovieCenter, and you are able to add these movies to your playlist. When played the external player starts and the MovieCenter disappear until the external player is closed.

File types

Select the file types you want to show inside the MovieCenter.

External player

Directory path of your external player

Parameters

Parameters to use with the external player

%1 = the selected file.

MusicCenter

The MusicCenter supports MP3, Wma, OGG and FLAC files.

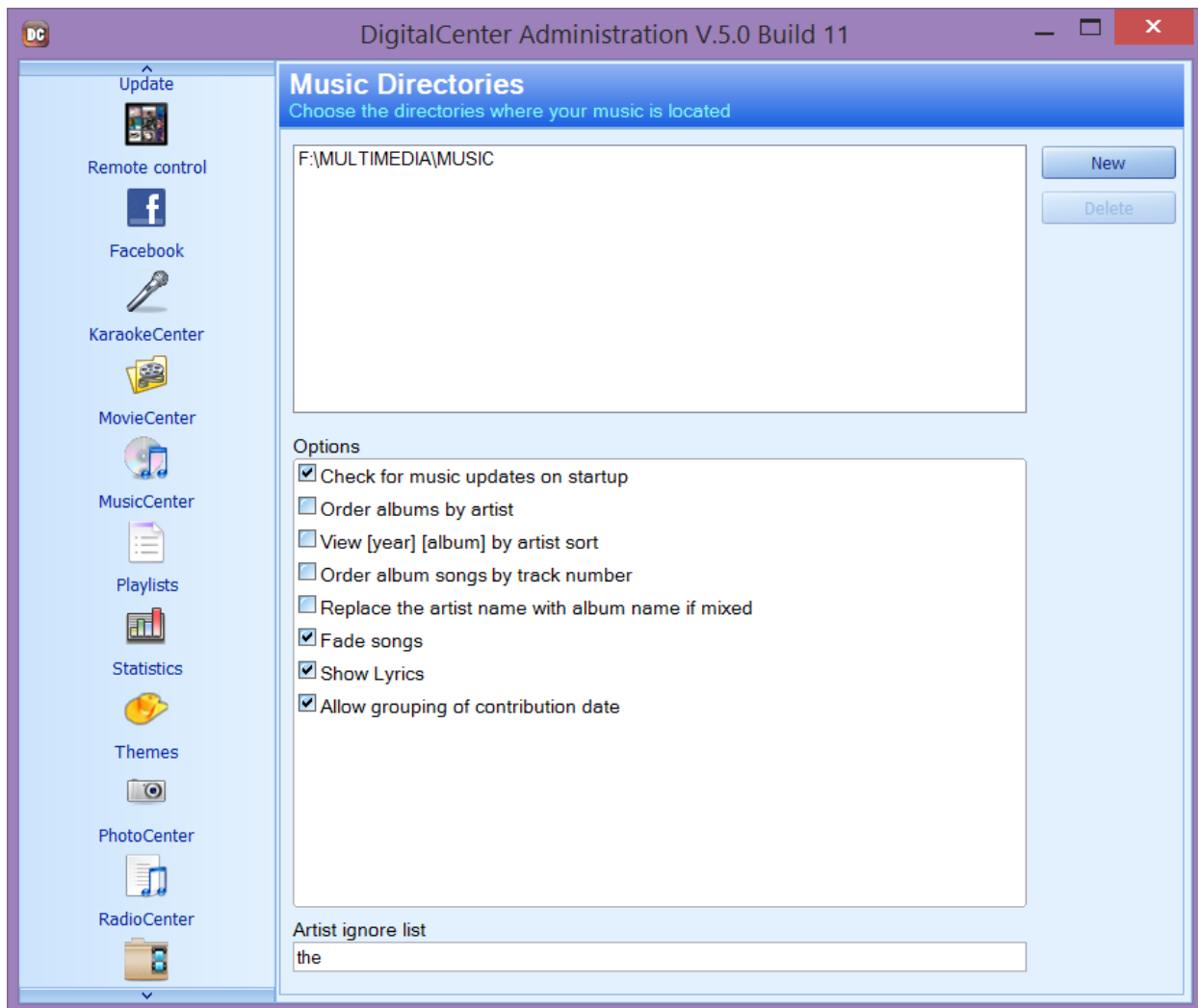

Music directories

Choose the directories where your music is located.

Options

Check for music updates on start up

Check your music for changes on hard drive every time you start the MusicCenter. If this is turned off the MusicCenter will only use a cached version and will ignore any changes you have made, but will speed up the music import of the MusicCenter.

Order albums by artist

Order your albums inside the MusicCenter by the artist instead of the title.

View [year][album] by artist sort

If you have chosen order albums by artist, it is possible to show the sub title as [year][album] and not just album title.

Order album songs by track number

Order your songs by track number instead of song title.

Replace the artist name with album name if mixed

If you have chosen to order your albums by artist name, and you have some albums with mixed artists, then this option tells the DigitalCenter to use the album name as title instead of "Mixed".

Fade songs

Do you want the DigitalCenter to fade songs in and out?

Show Lyrics

You are able to show lyrics together with music. If the screensaver is running or you have dual monitors setup, it is possible to have a lyric line, like this.



To use lyrics with the DigitalCenter you have to have a *.lrc file located together with your *.mp3 file, like this:

Because of You.mp3

Because of You.lrc

Your lrc file has to have the format [TIME]TEXT

```
[00:15.25]I will not make the same mistakes that you did
[00:22.91]I will not let myself cause my heart so much misery
[00:29.29]I will not break the way you did
[00:33.92]You fell so hard
[00:36.31]I learned the hard way, to never let it get that far
```

...

Allow grouping of contribution date

Makes it possible to group your albums by added date. This is great if you want to show all the latest albums added to your DigitalCenter. If this is turned on you will get a extra grouping icon in your grouping bar.



Artist ignore list

You have the opportunity to make an artist ignore list. This is practice if you have a lot of artists starting with words you will ignore for example "The Beatles", you are able to cut out word "The" and the artist is ordered by "B" instead of "T". Separate your ignore words with ";".

Playlists

Here you are able to create as many playlists as you like. With each playlist you are able to set up how the playlist should act when the DigitalCenter is running in party mode.

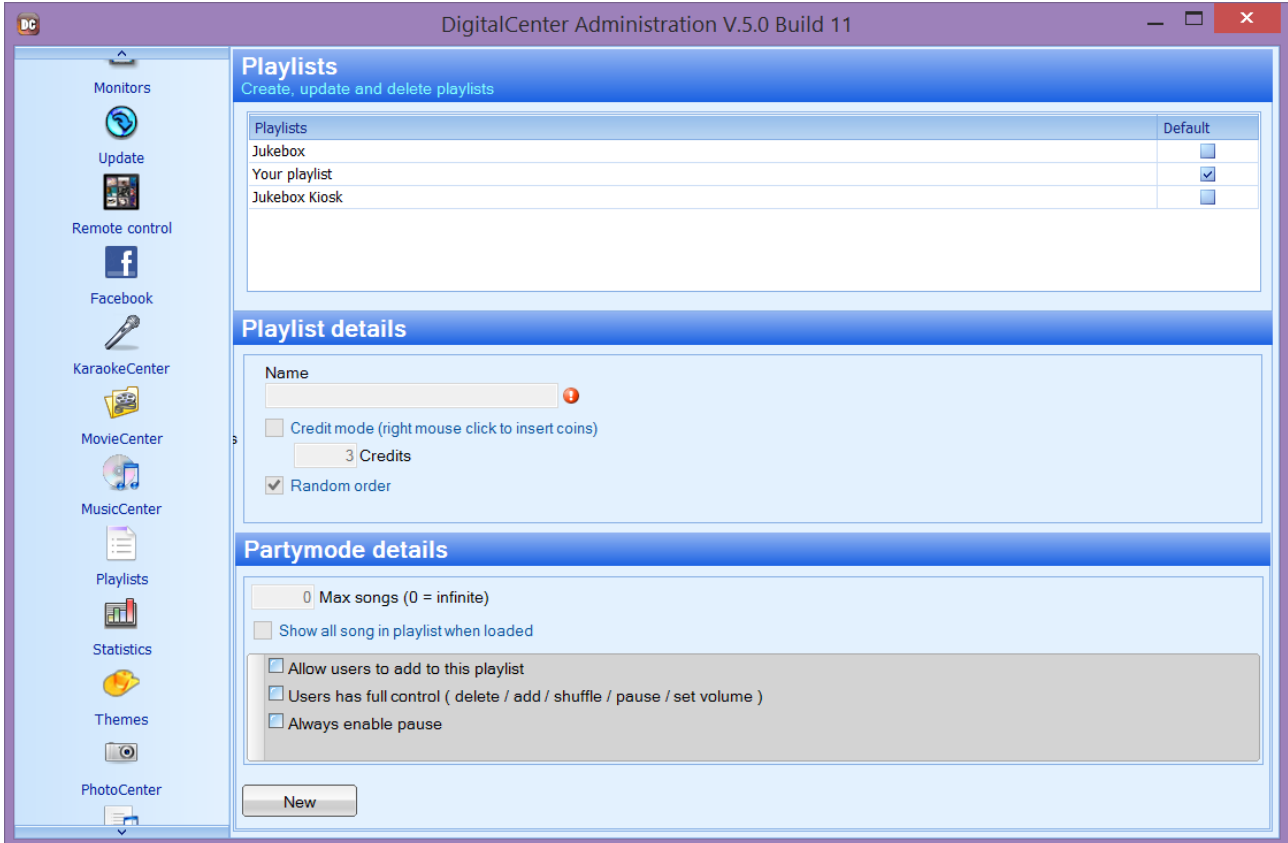

Playlist details

Name

The name of your playlist

Credit mode

If you have a coin acceptor added to your DigitalCenter it is possible to tell the current playlist you want to use credit mode. This mean your guests are only able to add new medias to the playlist if there are credit added to the DigitalCenter. You are able to simulate this by pressing the right mouse button or press "C" on the keyboard. If you want to know how to use a coin acceptor with your DigitalCenter, please read the section "Setting up a coin acceptor".



Credits

Tell the DigitalCenter how many credits to add when triggered.

Random order

Play songs from the playlist in random order.

Party mode details

This tells how the DigitalCenter how to behave when the playlist is loaded and you are in party mode.

Max songs

How many songs is it possible to add to this playlist. 0 means infinite.

Show all songs in playlist when loaded

There are two options for how the playlist can be used inside party mode. Either shows all the added tracks at once, and when new songs are added they will be added as the last songs in the playlist.

The second option is that the playlist songs are not shown but will add one of the songs every time the list is empty.

Allow users to add to this playlist

Anonymous users are allowed to add songs to this playlist.

Users has full control

Anonymous users are allowed to have full control like the party user with this playlist.

Always enable pause

The pause button is always allowed in this playlist.

Statistics

Show the statistics of your DigitalCenter over time.

DigitalCenter Administration V.5.0 Build 11

Overview

Sunday, May 04, 2014

Played items 2014:	0
Played items May 2014:	0
Played items Sunday, May 04, 2014:	0
Added by user 2014:	0
Added by user May 2014:	0
Added by user Sunday, May 04, 2014:	0

Year: **2014**

Month: 1 2 3 4 5 6 7 8 9 10 11 12

Months

Legend: ■ Played — User add

Drag a column header here to group by that column

Added	Title	Artist	Album	Genre	Year	Playlist

Themes

Themes are a filter for your song collection, for example if you don't want to be able to select Christmas music in the middle of the summer, you are able to make a new theme "No Christmas" and setup some rules which makes sure Christmas music is removed from your collection.

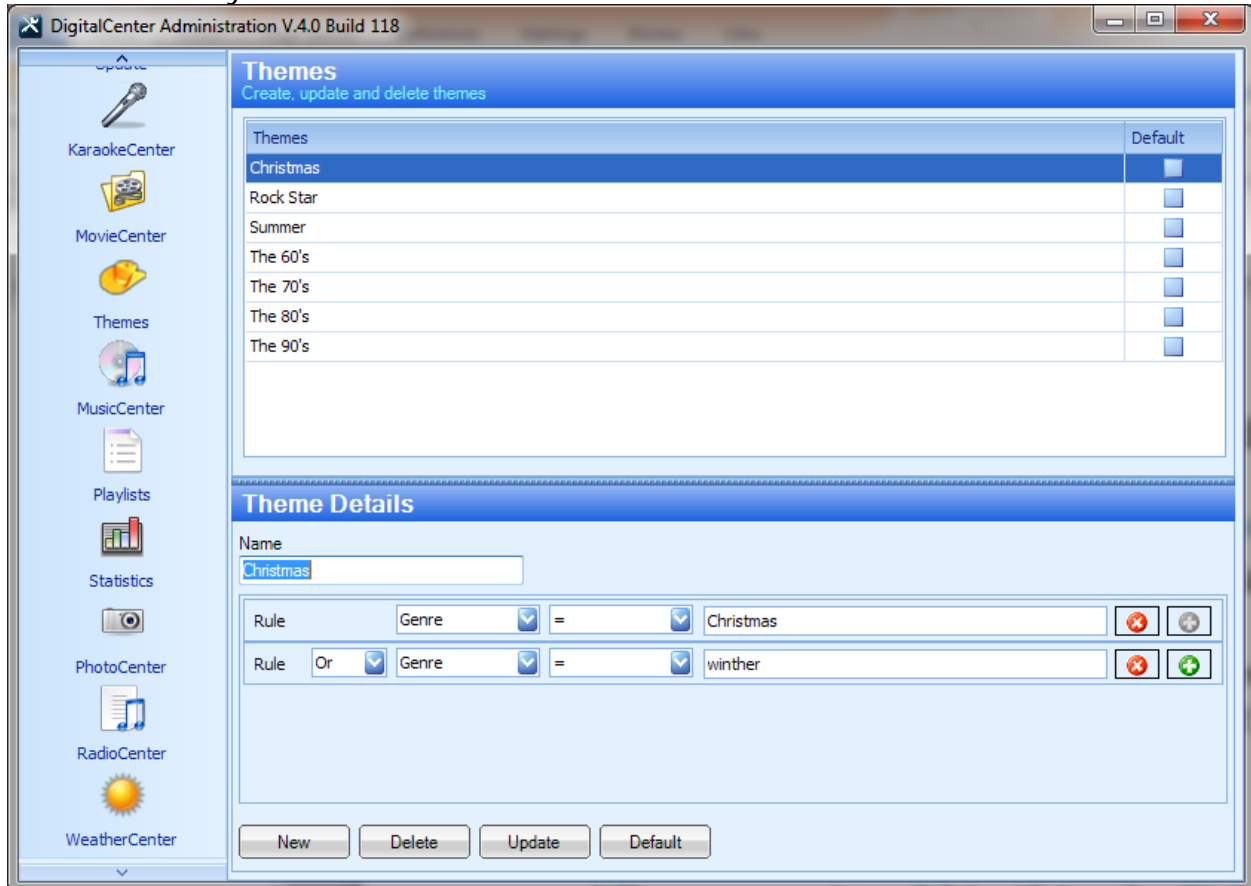

Themes

This is a list of all your themes. Select a theme and you are able to edit the rules.

Theme Details

Set up your rules for the selected theme.

Name

The name of the rule

Rule

Here you set up how the theme should act.

Add as many rules as you like for the theme. A rule is built by a tag to use, a compare symbol and a title to use.

If you have more than one rule you have to tell the theme if you want to use "And" or "Or", this mean if both rules has to be matched to select a song, or just one of rules has to match.

PhotoCenter

The PhotoCenter supports BMP, GIF, JPG and PNG files.

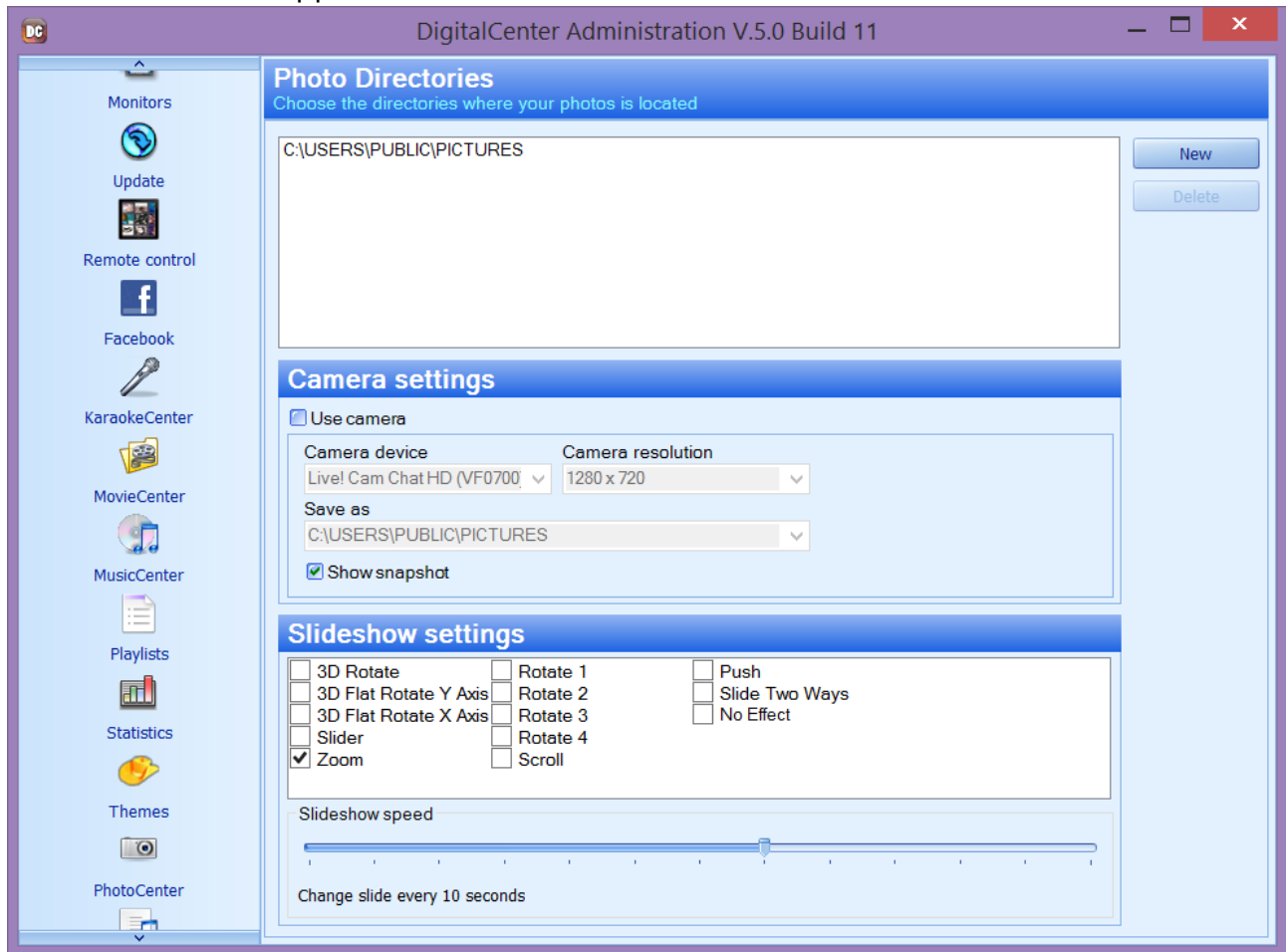

Photo directories

Choose the directories where your photos are located.

Camera settings

Use a camera to take snapshots with your DigitalCenter. This is great if you want to take photos from inside the DigitalCenter. You can use the snapshot button from the PhotoCenter or just use the key "T" on your keyboard.

Camera device

If you have one or more cameras connected to your DigitalCenter, setup which camera to use.

Camera resolution

Tell what resolution you want to use when you take snapshots.

Save as

What location to use for your snapshots.

Show snapshot

When a snapshot is taken you are able to see a preview at the right upper corner inside the DigitalCenter.

Slideshow settings

Transition effect to use with the photo slideshow.

Slideshow speed

Change how many seconds you want before changing photo inside the slide show.

RadioCenter

Add / delete your own radio stations to the DigitalCenter.

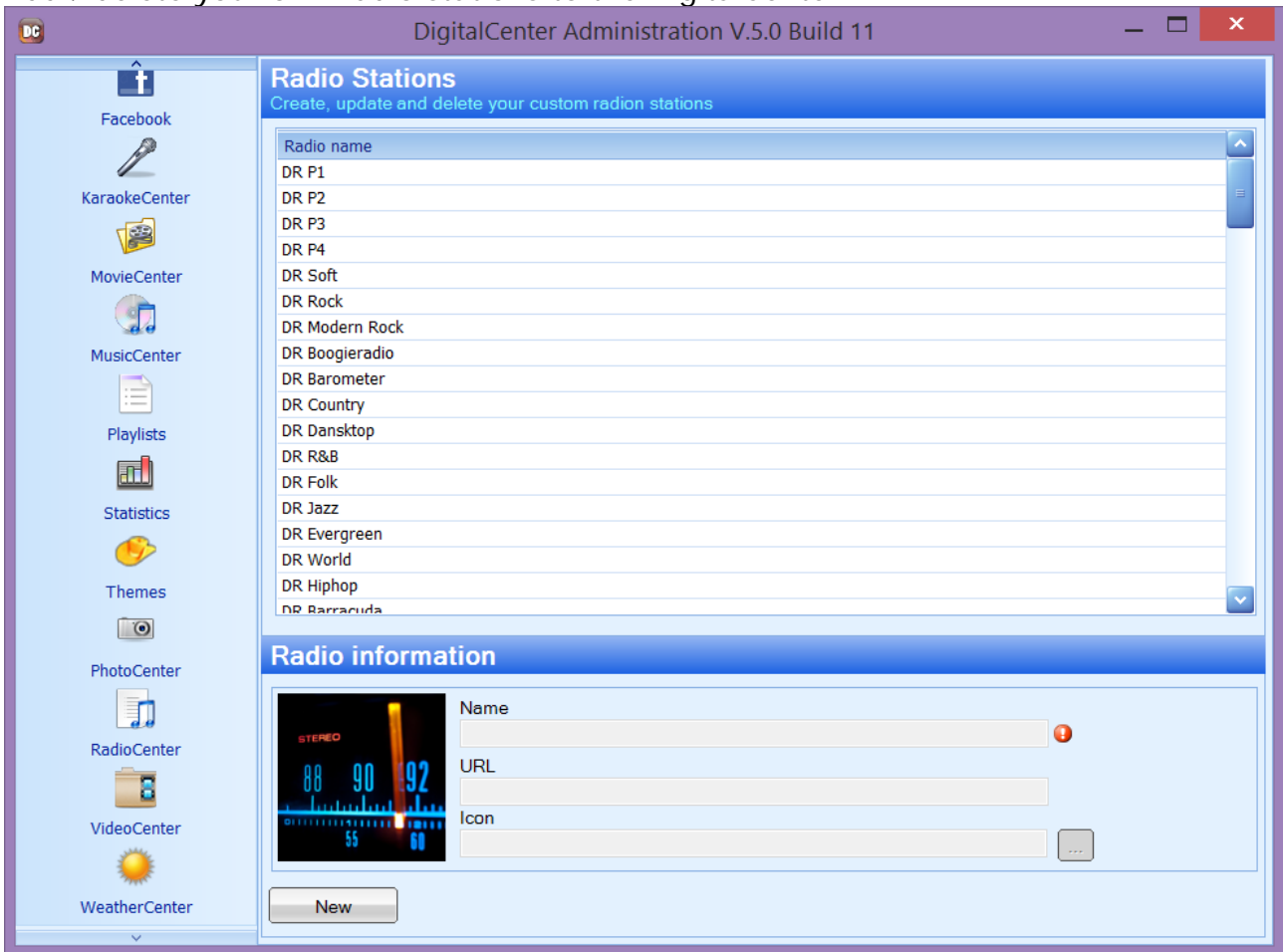

Radio information

Name

The title of the radio station you are adding.

URL

Insert the streaming URL of the radio station.

Icon

What icon to use with your custom radio station.

VideoCenter

The VideoCenter supports AVI, MKV, DIVX and MPG files.

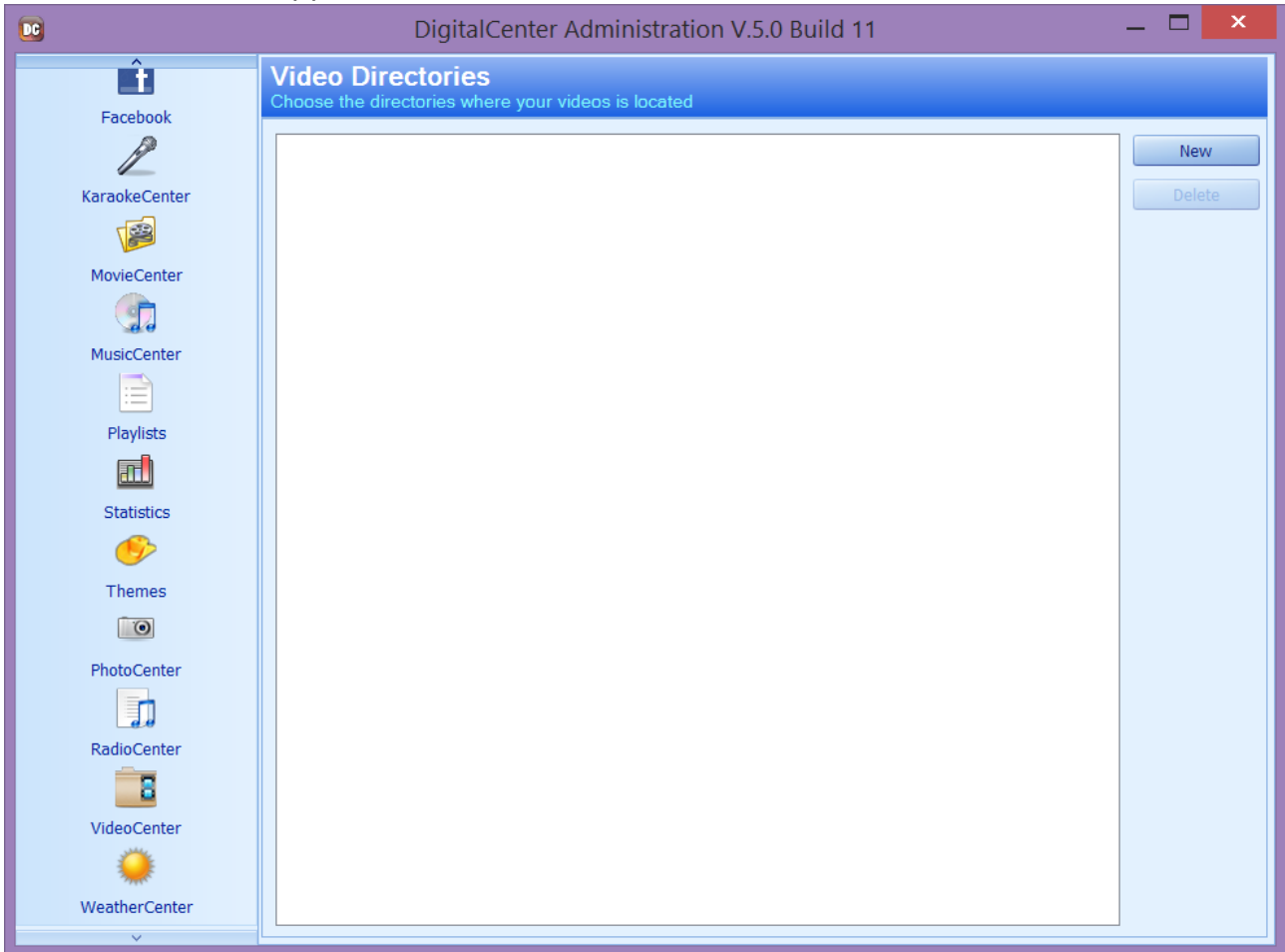

Video directories

Choose the directories where your videos are located.

WeatherCenter

Find the city to use for your forecast.

Write your city and find it in the list below. Double click the city to change the current

city.

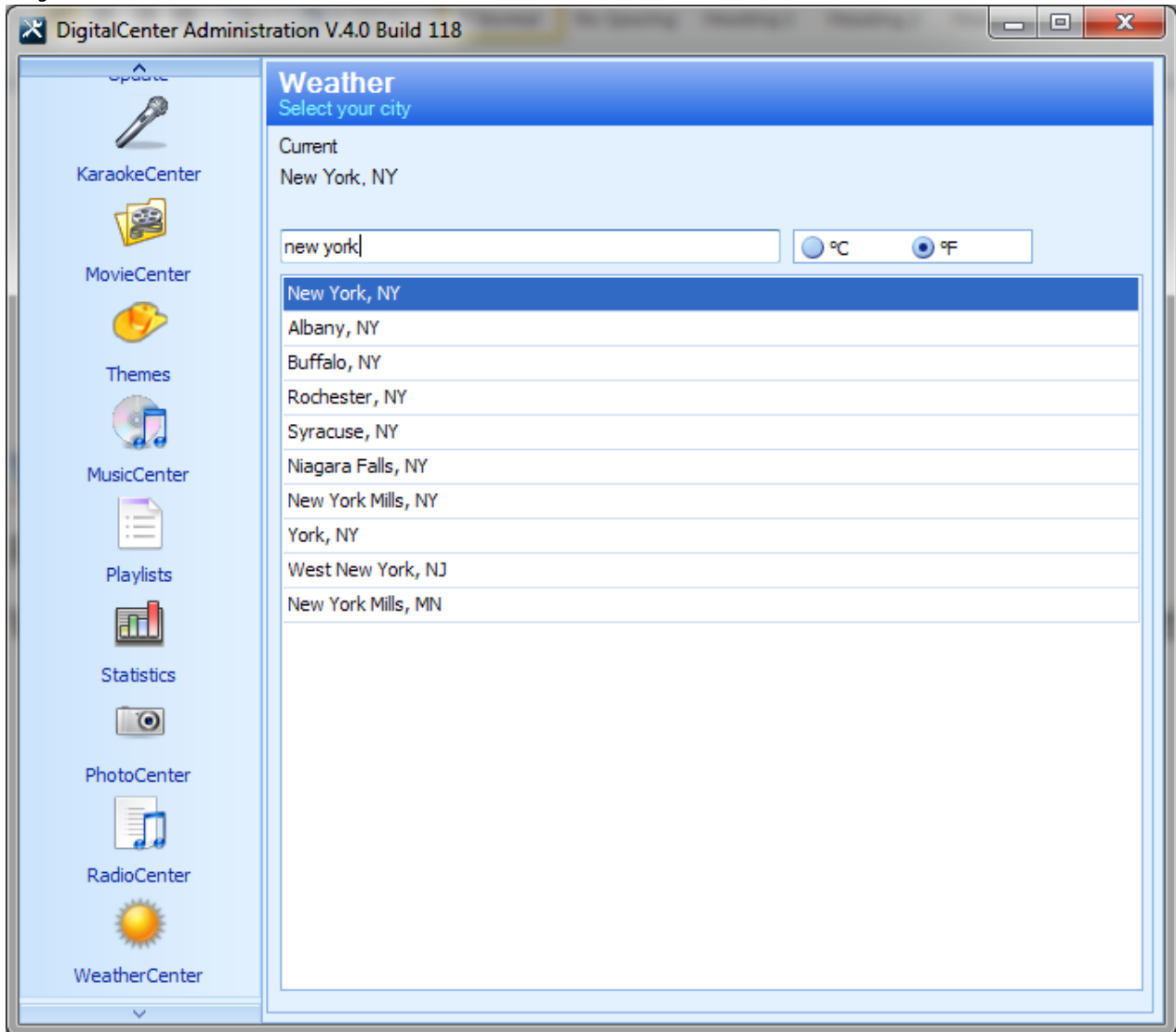

DigitalCenter

With ZenPoint DigitalCenter, you can listen to your own music, to online radio, see your favourite movies or enjoy your Photos in a nice slideshow.

ZenPoint DigitalCenter comes with more than 30.000 different radio stations. ZenPoint DigitalCenter can be configured to meet all your needs, from a private music centre to a jukebox or a slideshow of all your images.

DigitalCenter comes with 13 different languages



The home page is a collection of all your plugins and external programs. Select a plugin to jump directly to the plugin.

From the home page you are able to close your DigitalCenter or change the settings inside the program, if you are in party mode none of the changes are saved but are used as long as the DigitalCenter is running.

You are also able to click the status bar below to jump directly to the playing item.

Settings

Inside the settings you are able to change the look and feel of your DigitalCenter.



Skins

choose the skin to use with your DigitalCenter.

Themes

Select / Unselect the theme to use as a filter of your music collection. For example if you don't want to be able to select Christmas songs in the middle of the summer, you are able to make a theme "no Christmas" which disables all Christmas songs from your collection.

Effects

choose the effect to use with your DigitalCenter.

Playlist

Load or create a new playlist.

Languages

select your language.

Reset music

Reset your music collection and reset all cover arts.

Administration

Disable the DigitalCenter and start the administration. The DigitalCenter will restart when the administration is closed.

Party mode

set your DigitalCenter into party mode.

Rip CD

Rip your music CD's. The DigitalCenter is using the Windows media player to rip your CD's. Make sure to set your windows media player rip location to a music location your DigitalCenter is listening to.

Remote Control

If you have turned on Remote Control from the administration, you are able to control your music center from a smart phone or a tablet. Just click on Remote Control and write the current remote control address into your web browser on your smart device.

DigitalCenter LIMITED EDITION WWW.ZENPOINT.ORG ZenPoint

Remote control

Use the following url on your mobile phone

<http://192.168.10.39:18000>

Logged in as admin user

 **Daddy cool**
Boney M. Gold 03:21

Back Pause Next Volume

Copyright ©2007-2014 by ZenPoint. All rights reserved. www.zenpoint.org



MusicCenter

ZenPoint MusicCenter provides a complete and comprehensive overview of your music. It's easy to find the music you're in the mood to hear. Create your own playlists with your favourite music as easy as ABC.

The MusicCenter is also great for parties, with one click, you can set your MusicCenter into Party mode, and it will act like a Jukebox.

Navigate through albums, artists, songs, genre, years or even free text search. It has never been easier to navigate to a specific song.

Albums

this page shows your collection by albums. Just select an album and you are redirected to all the songs of this album.







Navigation

There are many way to navigate through the collection.

1. Use the arrows to navigate backward or forward.
2. Use the alpha slider.
3. Use the lightning symbol ⚡ to the left of the alpha slider to fast index navigation.
4. Use the half circle ◐ above the alpha slider to speed navigate, just slide left or right.

Grouping

you are able to group your albums by artists, genre or years by clicking the grouping symbol  to the right of the alpha slider

	Group by artists
	Group by genres
	Group by years

Artists

this page shows your collection by artists. Just select an artist and you are redirected to all the songs of this artist.



Navigation

There are many way to navigate through the collection.

1. Use the arrows to navigate backward or forward.
2. Use the alpha slider.
3. Use the lightning symbol ⚡ to the left of the alpha slider to fast index navigation.
4. Use the half circle ◐ above the alpha slider to speed navigate, just slide left or right.

Songs

This page shows your collection by song titles. Just select a song and are able to add the song to the playlist.







Navigation

There are many way to navigate through the collection.

1. Use the arrows to navigate backward or forward.
2. Use the alpha slider.
3. Use the lightning symbol ⚡ to the left of the alpha slider to fast index navigation.
4. Use the half circle ◐ above the alpha slider to speed navigate, just slide left or right.

Sorting

you are able to order the collection by albums, artists, genre or years by clicking the grouping symbol 🎵 to the right of the alpha slider

	Order by albums
	Order by artists
	Order by genres
	Order by years

Genres

This page shows your collection by genres. Just select a genre and you are redirected to all the songs of this genre.



Navigation

There are many way to navigate through the collection.

1. Use the arrows to navigate backward or forward.
2. Use the genre slider.
3. Use the lightning symbol ⚡ to the left of the alpha slider to fast index navigation.
4. Use the half circle ◐ above the alpha slider to speed navigate, just slide left or right.

Years

This page shows your collection by years and centuries. Just select a year and you are redirected to all the songs of this year.



Navigation

There are many way to navigate through the collection.

1. Use the arrows to navigate backward or forward.
2. Use the genre slider.
3. Use the lightning symbol ⚡ to the left of the alpha slider to fast index navigation.
4. Use the half circle ◐ above the alpha slider to speed navigate, just slide left or right.





Search

Here you are able to search through all your songs, artists or albums. The search uses auto completion, which means it will search your collection as soon as you begin typing. The search uses word search which means you don't have to know a whole sentence or the whole word, just remember a part of a word in the title, album or artist. It doesn't even matter what order you write your words. For example a sentence like "A girl like me" will be found even if you can't remember all the words like "girl me".



Search type

By default the DigitalCenter search for all albums, titles and artists, but you are able to choose to search only for one of those by clicking the three dots  to the left of the zoom class.

	Only search for albums
	Only search for artists
	Only search for song titles
	Search for all

Navigation

Use the arrows to navigate backward or forward.

Playlist

The playlist page shows you all the media items in you playlist and shows you when they are going to play. You are able to delete the whole playlist or shuffle all the items. If you want to navigate to a specific album from one of the songs, you can ether click on the song and a add item pops up, now click the cover art to the left and you are redirected to the album. Another way is just to click on the cover arts to the left on the playlist page, and an album select pops up and you are able to click the album you want to jump to.



Navigation

Use the arrows to navigate backward or forward.

Song select / Album select

This page shows a collection of songs from your choice from the previous page for example an album select, a genre select or a year select.







Navigation

There are many way to navigate through the collection.

1. Use the arrows to navigate backward or forward.
2. Use the alpha slider.
3. Use the lightning symbol ⚡ to the left of the alpha slider to fast index navigation.
4. Use the half circle ◐ above the alpha slider to speed navigate, just slide left or right.

Sorting

you are able to order the collection by albums, artists, genre or years by clicking the grouping symbol 🎵 to the right of the alpha slider

	Order by albums
	Order by artists
	Order by genres
	Order by years

Show as albums

You are able to show the selected collection as album arts instead of songs, just click the cover art to the left and you are presented with the following popup.



From here just select the album you want to be redirected to.



MovieCenter

Navigate through all your favourite movies with ZenPoint MovieCenter. Organize your movies into categories like "Family movies", "Action movies", "Music videos", "Fun movies" and so on. It's easy to use ZenPoint MovieCenter even your kids can control ZenPoint MovieCenter and have their own category.

With the MovieCenter selected, you can easily go through your movie collection, and watch your favourite movies.

You can even add your movies to the selected playlist, this is a nice feature when you are playing music videos or just want your kids to be quiet for the next 10 hours.

Add a description to your movie

You are able to show a description of your movies like the picture below:



You just have to put a XML file next to your movie file and the name has to match the movie filename, like this:

MeetTheRobinson.avi
MeetTheRobinson.xml

The xml file shall look like this.

```
<?xml version="1.0" encoding="utf-8"?>
<movie>
  <title>Meet the Robinson</title>
  <description>Lewis is a brilliant....</description>
  <year>2000</year>
  <genre>action</genre>
</movie>
```



KaraokeCenter

With ZenPoint KaraokeCenter you are able to navigate or search through your karaoke collection. Just pick a karaoke song and press play and you are ready to sing along. You can even put your karaoke songs into the current playlist to make sure the songs are played in the order they have been added.

ZenPoint KaraokeCenter has dual monitor support, which is great for parties where some of your guests are able to navigate and select songs while other guests are able to sing along to the current playing karaoke song.



RadioCenter

With the RadioCenter you can listen to your favourite radio stations. ZenPoint RadioCenter comes with more than 30.000 difference stations, and if this not enough you have the opportunity to add your own online radio stations.

If you have the PhotoCenter plugin added to the DigitalCenter, you can make your DigitalCenter into a photo frame slideshow while you are listening to your favourite radio stations.

PhotoCenter

Look through all your family photos. Go to a specific photo or see a slideshow while you're listening to your music or a radio station.

The system makes it possible to see the description of your photo and when the photo was taken. It's easy to navigate through all your family photos and find the one you are looking for. You can also choose a specific folder and turn your PhotoCenter into a slideshow.

Share with facebook

If you have turned on Facebook inside the administration, you are able to share your photos on your wall by pressing the facebook icon to the right of your photo.

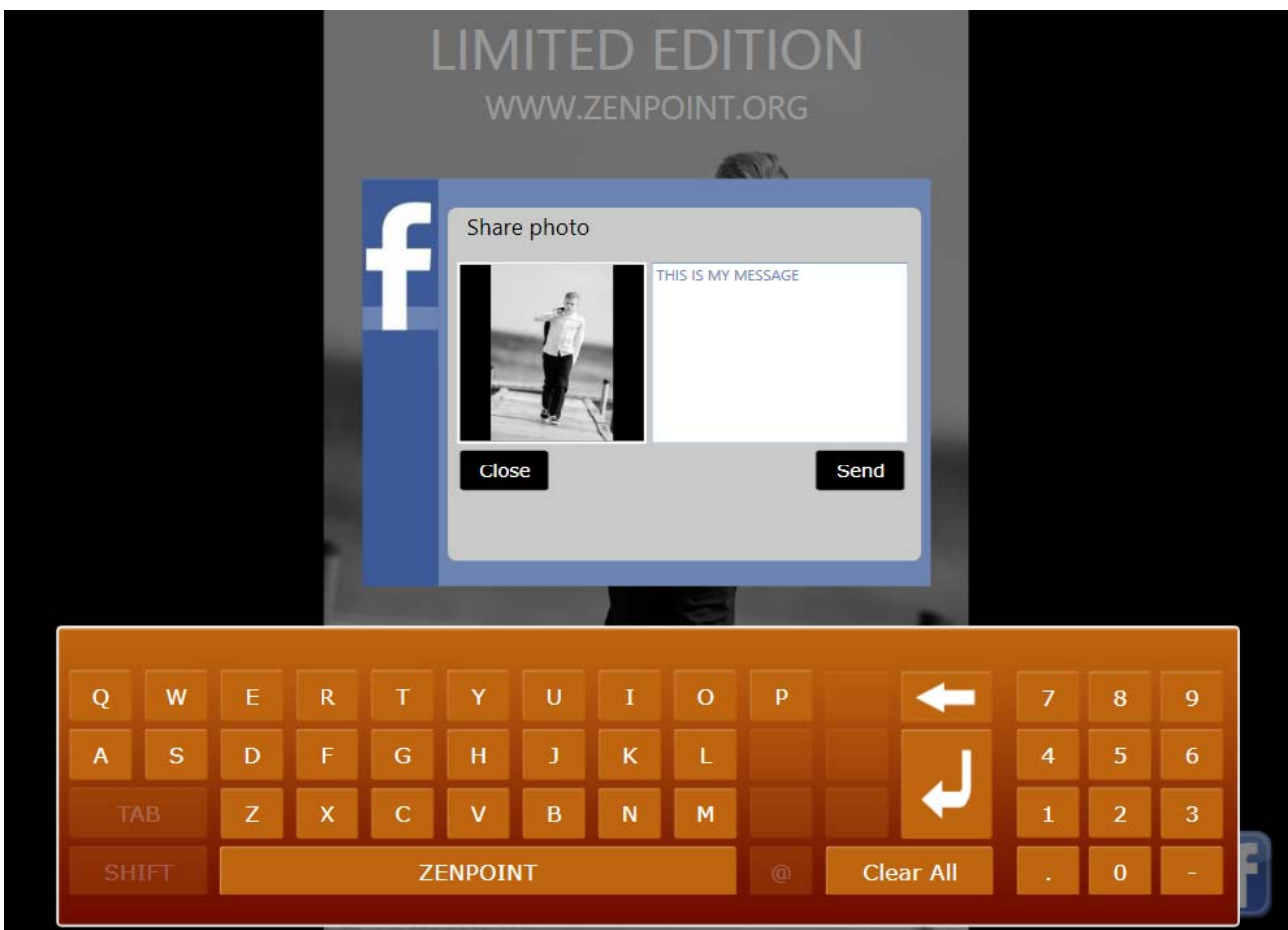

WeatherCenter

The WeatherCenter is used to watch the current weather forecast in a nice and easy way. You can see the weather forecast right now, and the next 5 days.

Trial version / Limited edition

If you are running the DigitalCenter as a trial version, you are able to run the DigitalCenter 7 days. In the trial version you will see a watermark "Limited edition" at the top of your screen.

Limitations

When you are using a trial version, you are able to run all features inside the DigitalCenter, but your medias will only play 25% of the duration. If you play a radio station this will only play for 2 minutes.

Purchase

After your seven days of trial you will no longer be able to run the DigitalCenter and have to buy a valid license to continue to use your DigitalCenter and remove all limitations.

Buy a valid license from our homepage: <http://www.zenpoint.org/Purchase>

Setting up a coin acceptor

It is easy to add a coin acceptor or a bill acceptor to your Digital Center.

You can just use the right button of a computer mouse as the coin trigger.

Look at the following diagrams

How to connect a Coin Mechanism to your PC

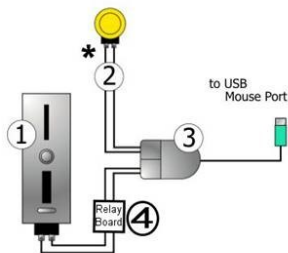

1. Coin Acceptor on left button
2. Coin Acceptor2 on right button
3. USB Mouse
4. Relay board

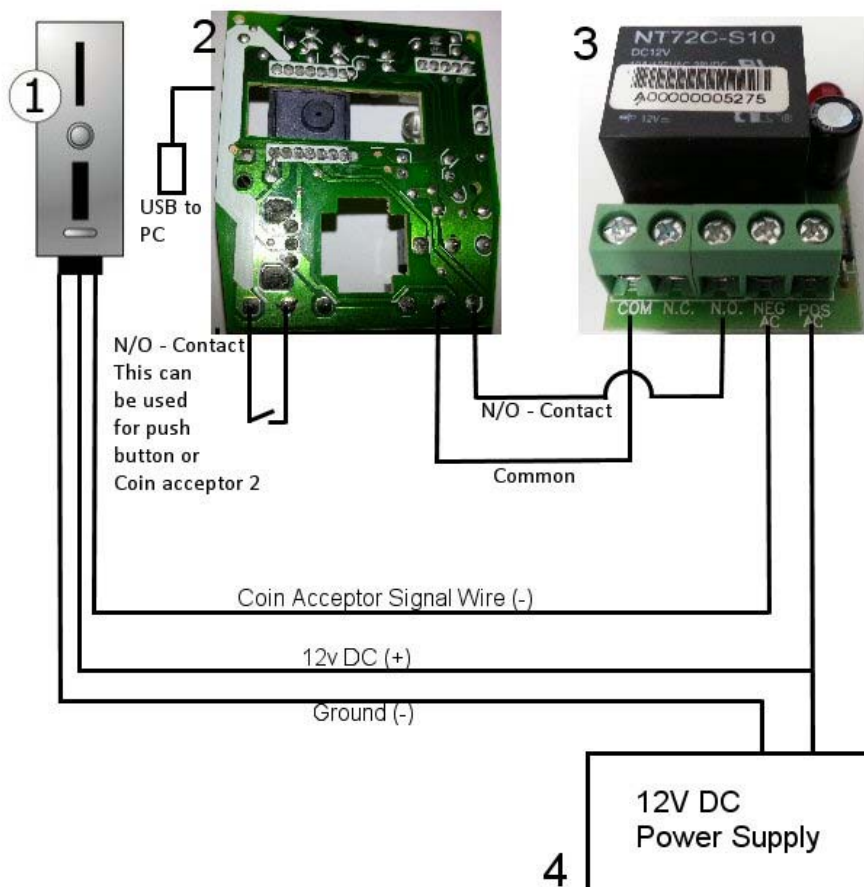

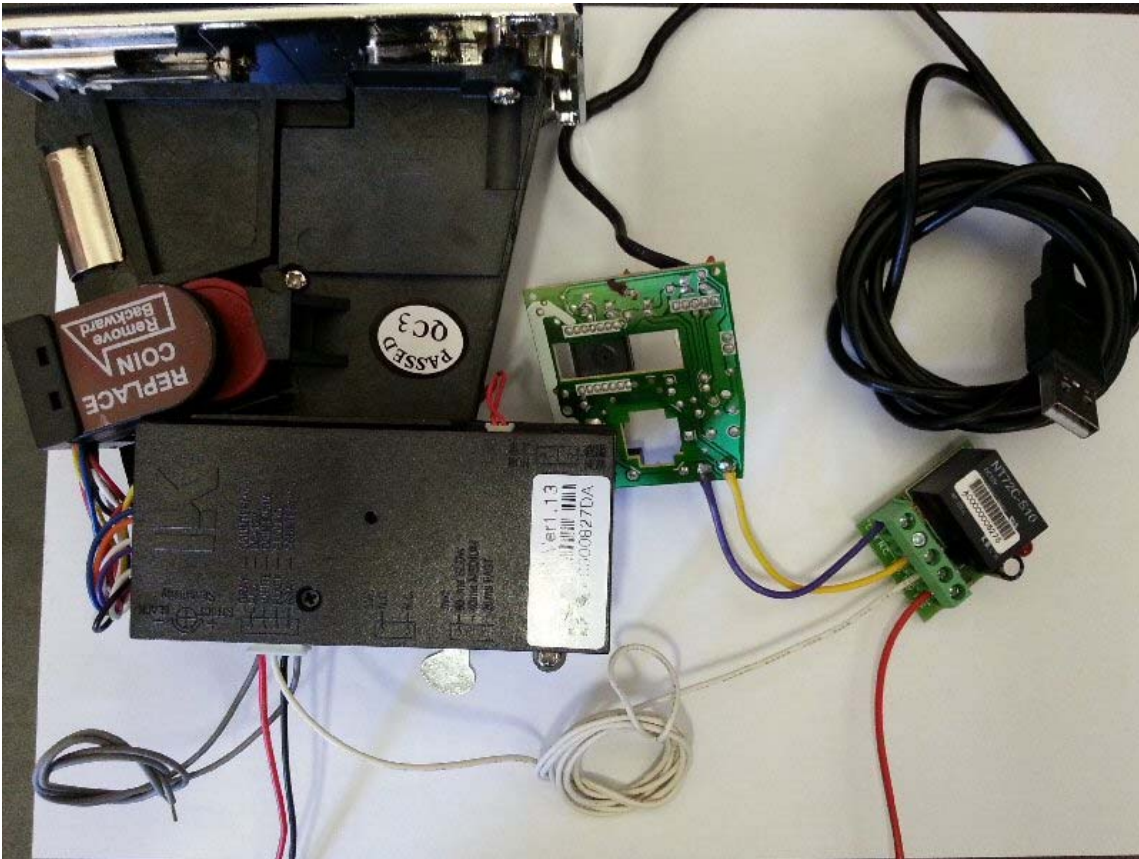

Your comments

If you have any comments to this product, you can visit <http://www.zenpoint.org>

FAQ

1. How do I add music to the MusicCenter?

To add music to your MusicCenter you first have to convert your music CD to mp3 files, and place those files in a directory of your choice. Inside the administration / MusicCenter locate the directory.

Find an image that corresponds to your album and copy the image into the same directory. To speed up loading time, change your image size to 500x500 pixels. It is also possible to create embedded cover arts inside your mp3 files.

Next time you run ZenPoint DigitalCenter, the system will find your new album.

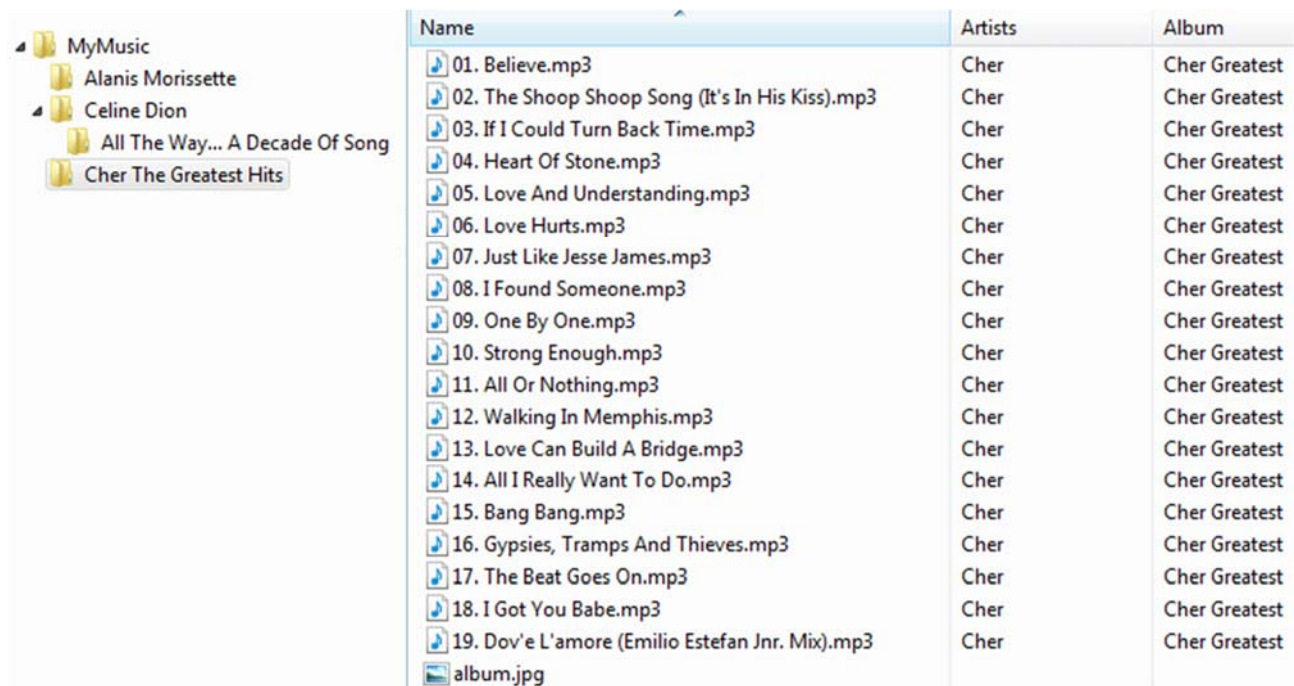

Name	Artists	Album
01. Believe.mp3	Cher	Cher Greatest
02. The Shoop Shoop Song (It's In His Kiss).mp3	Cher	Cher Greatest
03. If I Could Turn Back Time.mp3	Cher	Cher Greatest
04. Heart Of Stone.mp3	Cher	Cher Greatest
05. Love And Understanding.mp3	Cher	Cher Greatest
06. Love Hurts.mp3	Cher	Cher Greatest
07. Just Like Jesse James.mp3	Cher	Cher Greatest
08. I Found Someone.mp3	Cher	Cher Greatest
09. One By One.mp3	Cher	Cher Greatest
10. Strong Enough.mp3	Cher	Cher Greatest
11. All Or Nothing.mp3	Cher	Cher Greatest
12. Walking In Memphis.mp3	Cher	Cher Greatest
13. Love Can Build A Bridge.mp3	Cher	Cher Greatest
14. All I Really Want To Do.mp3	Cher	Cher Greatest
15. Bang Bang.mp3	Cher	Cher Greatest
16. Gypsies, Tramps And Thieves.mp3	Cher	Cher Greatest
17. The Beat Goes On.mp3	Cher	Cher Greatest
18. I Got You Babe.mp3	Cher	Cher Greatest
19. Dov'e L'amore (Emilio Estefan Jnr. Mix).mp3	Cher	Cher Greatest
album.jpg		

2. How do I change the title or album name of my music?

To change the properties of a MP3 file, go into your windows explorer and right click on the MP3 file and select "properties", select "Details", now you can change all the property detail of the MP3 file.

To make this easier, we recommend that you download the program Mp3tag which is free.

<http://www.mp3tag.de/en/>

3. How do I add descriptions to my photos?

To add a description to your photos, go into your windows explorer and right click on the photo file and select "properties", select "Details", add a title to the photo and click apply.

4. How can I streamline the volume of all my music?

It is possible to streamline the volume of all your music, so you avoid some of your songs being played in a higher volume than others.

To streamline your songs volume level, you must download Mp3Gain. In this program, select the volume you want for all your music.

<http://mp3gain.sourceforge.net/download.php>

5. What is Party Mode?

ZenPoint DigitalCenter is ideal for parties because it is possible to activate Party Mode. With Party Mode on, nothing will be saved and you do not have to worry about your guest's damages your Playlist or setups.

When Party Mode is set, it will be possible for your guests to add music to the Playlist, but these will only be saved temporarily, next time you run DigitalCenter, all added songs will be removed.

In Party mode, you have to use a password to be able to go back to the main menu you can set up the standard password inside the ZenPoint administration.

There are 2 types of user passwords that can be configured, a "party user" and an "admin user". When you are logged in as a "party user" you have complete control over the playlist, but none of the changes you make will be saved. As "admin user" you have full control over ZenPoint DigitalCenter, and all changes will be remembered.

If you rent jukeboxes to customers, it is also possible to set the party mode on by default.

6. How to make a jukebox with ZenPoint MusicCenter?

If you want to make your own jukebox, then ZenPoint MusicCenter is the right choice.

Go into ZenPoint administration. Select your language, default skin, effect and volume for your jukebox.

- Setup your party mode / admin user password
- If your jukebox runs on a touchscreen, turn on touchscreen.
- Turn on "Start in party mode".
- Turn off "Show administration in setup".
- Turn on "Hide party mode from setup"
- Change your default "party mode" password
- Setup external programs for the party mode user and the admin user.
- Inside the plugins turn off all the plugins except the MusicCenter.

Close down the administration and go into DigitalCenter / MusicCenter login as admin user, and fill up your playlists. When the jukebox is in party mode, it is only the admin user who can add and save to the playlists.

If you want a shutdown button inside your jukebox menu, then make an external program for the "shutdown.exe" program.

That's it, congratulations with your new jukebox.

7. How to create a playlist?

It is easy to create Playlist in your MusicCenter this can either be done by going into settings / setup if you're not in party mode.

1. Choose "Add" to add a new playlist.
2. The second way is to add through ZenPoint administration, you can also choose how the playlist is used in party mode.

8. How do I add pictures and titles to my movies?

Create a picture with the same file name as your movie, and place it in the same directory.

Like this:

c:\movies\Cartoons\shrek.avi

c:\movies\Cartoons\shrek.jpg

To write a title for the movie, go into your windows explorer and right click on the picture just added and select "properties", select "Details", add a title of the movie and click apply.

9. The MusicCenter plays the song but where is the sound?

If you are using an older version of Microsoft Media Player, you may experience that there is no sound through your speakers when the music plays.

Download the latest version of Microsoft Media Player.

<http://www.microsoft.com/downloads/en/resultsForCategory.aspx?categoryid=4&displaylang=en>

10. The MovieCenter doesn't play any movies

If you are using an older version of Microsoft Media Player, you may experience that the MovieCenter will not play any of your movies.

Download the latest version of Microsoft Media Player.

<http://www.microsoft.com/downloads/en/resultsForCategory.aspx?categoryid=4&displaylang=en>

11. How to minimize the DigitalCenter?

ZenPoint DigitalCenter has some hotkeys for minimizing the windows

F12 = Switch from and to full screen

Shift F12 = minimize window

Ctrl F12 = Fixed size scale window

F5 = Switch stretch screen.

12. How to sort albums by artist?

Go into the administration, under general and check the option "Order albums by artist"

13. How to sort albums songs by tracks?

Go into the administration, under general and check the option "Order album songs by track number"

14. How to create my own skin?

Inside the directory where you installed ZenPoint DigitalCenter there is a "Themes" directory with all your installed skins, make a copy of the skin directory you want to build from. Inside the directory there is a "theme.xaml", this is where all the colours/logo/positions is set up. There is also a directory named "Images" with all the images used inside the program.

15. How to remove the ZenPoint logo?

Inside the directory where you installed ZenPoint DigitalCenter there is a "Themes" directory with all your installed skins, jump into the skin where you want to remove the logo. Open the Theme.xaml, and change the line:

```
<visibility x:key="LogoVisible">Visible</visibility>
```

To

```
<visibility x:key="LogoVisible">Hidden</visibility>
```

16. How can I jump to the album of a search result

In the search result, choose a song which contains the album you want, in the add playlist dialog box press the cover art, and you are redirected directly to this album.

Releases

Release 5.0

Camera support. Take photos. (shortcut T)

Share photos on Facebook

Quick menu. Jump between plugins in party mode.

Attractive mode. If playlist empty play a song each X minutes.

Allow to change plugin names

Karaoke zip file support

Save playlist for an hour if system crash.

Scrolling title in screensaver

Custom cover art for RadioCenter

Setup screensaver timer

Release 4.5

Coin Acceptor support

Order songs or albums by recently Added dates

Support multi word search on the Remote control

Disable system keys

Enable media keys in party mode

Release 4.4

KaraokeCenter: support of individual cover arts. Name: [karaoke name].jpg

WeatherCenter: Changed WeatherCenter data provider

Release 4.3

Optional show of [Year][Album] when artists order sort

Optional select of EVR (Enhanced Video Renderer) in MovieCenter

improvements for the remote control

Allow streaming of your music to your mobile device

Scrolling artist name in the screensaver when the name is too long.

Greek language added (Thanks to Jannis from greece)

Release 4.2

Enlarged the movie description

EVR Presenter in the moviecenter

Better performance on multi monitors

Collect movie information and cover from IMDB

Faster movie navigation on external movies

Choose movie types for internal player

Release 4.1

CD ripper

IPad, iPhone and iPod touch remote control support

Order albums by artists is now ordered by "Artist / Year / Album Title"

Replace the splash screen with your own image

M4a file support

Release 4.0

Add songs in the same order as listed.

Possibility to play licensed wma files

Possibility to change slideshow speed.

Possibility to create a ignore list for artists like "The Beatles" ignore "The".

Use the tag "Album Artist" if Various Artists.

Added Sort by artists

Replace the artist name to album name if mixed

Order album songs by track number

Order albums by artistKaraokeCenter (cdg files)

WeatherCenter

Release 3.9

Speedbar for better navigation on big collections

Positionsbar for better navigation on big collections

Better random sorting of playlists

Grouping albums by genre, artist, years

Sort songs by title, artist, track, genre or year

Supporting flac and ogg file types

Search filter by artist, album or title

Better support of dual monitors when the desktop is extended.

Possibility to stop music from playing when playlist is empty

Keep playing movie when leaving moviecenter

Possibility to mix songs, movie, karaoke and radio in the playlists

Cover select box

Release 3.8

Possibility to start a specific plugin when the DigitalCenter is started.

Possibility to make own themes.

Possibility to start a plugin through parameters like (digitalcenter.exe /musiccenter)

Possibility to add descriptions to your movies through the comment meta tag or a XML file

Possibility to click on the status bar to jump to the playing plugin.

Possibility to turn off splashscreen and copyright line.

Possibility to use external movie players with your DigitalCenter "for example VLC".

Possibility to have the slideshow run as screensaver.

Possibility to change screensaver background

Manual updated

Release 3.7

Remote Control support

Delete radio history

Disable automatic text formatting

New skins added

Release 3.6

Disable navigation effects

Create your own NoCover art. Located inside Themes.

Screensaver feature

Splash screen feature

Release 3.5

Better Multi monitor display for RadioCenter and MusicCenter.

Touch Control, navigate with finger sliding instead of the arrows.

Play and volume control added to MovieCenter and PhotoCenter

Thanks to Henning from Norway for the Norwegian translation

Thanks to Petra from Sweden for the Swedish translation

MP3 mutated vowel support.

Release 3.4

Show percent when importing music

Choose quality of your images from the administration

Dutch language added. Thanks to Fred from the Netherlands.

Improvements of the administration account.

Possible to replace the windows shell with the DigitalCenter.

Add your own icons to your external programs instead of the shell icon.

The missing manual is added

Turn song fading off